



R70

Commercial Fitness Bike

Congratulations on choosing a VISION FITNESS Bike. You've taken an important step in developing and sustaining an exercise program! Your Bike is a tremendously effective tool for achieving your facility's fitness goals. Regular use of your Bike can improve the quality of your members' lives in so many ways.

Here are just a few of the health benefits of aerobic exercise:

- Weight Loss
- A Healthier Heart
- Improved Muscle Tone
- Increased Daily Energy Levels
- Reduced Stress
- Help in Countering Anxiety and Depression
- An Improved Self Image

The key to reaping these benefits is to develop the exercise habit. Your new Bike will be an important tool in helping your members achieve this exercise habit. This Owner's Guide provides you with basic information on using this VISION FITNESS Bike. A more complete knowledge of your new Bike will assist you in helping your members achieve their goals.

Some kinds of service to your Bike should only be performed by your VISION FITNESS retailer. Please contact your authorized VISION FITNESS retailer should service be required. If a question or problem arises which cannot be handled by your VISION FITNESS retailer, please contact us:

VISION FITNESS
 1600 Landmark Drive
 Cottage Grove, WI 53527
 Ph: 1.800.335.4348
 Fax: 1.608.839.8731
 www.visionfitness.com

Table of Contents

INTRO

SAFETY INSTRUCTIONS.....	4
ASSEMBLY & MOVING THE BIKE	6
STABILIZING THE BIKE, PEDAL STRAP ADJUSTMENT.....	7
SEAT ADJUSTMENT, LUMBAR ADJUSTMENT.....	9
SELF-POWERED FEATURE.....	10
CONTACT HEART RATE.....	11

CONSOLE

DISPLAY CONSOLE	12
DISPLAY CONSOLE DESCRIPTIONS....	13
CARDIO PORT, BATTERY	15
PROGRAM OVERVIEWS	16
USING THE PROGRAMS.....	20
USING THE SPRINT 8 PROGRAM	22
USING HEART RATE TRAINING.....	23
TELEMETRIC HEART RATE CHEST STRAP, PLACEMENT.....	24
ALL HRT PROGRAMS, ADJUSTING TARGET HEART RATE	25
USING CUSTOM PROGRAMS.....	26
ENGINEERING MODE.....	28

GENERAL

PREVENTATIVE MAINTENANCE.....	29
TROUBLESHOOTING.....	30
TROUBLESHOOTING HEART RATE MONITOR CHEST STRAP	32
LIMITED HOME USE WARRANTY.....	34
COMMERCIAL WARRANTY	36
DEVELOPING A FITNESS PROGRAM...	38
EXERCISE GUIDELINES	39
TARGET HEART RATE	40
BALANCED FITNESS	41

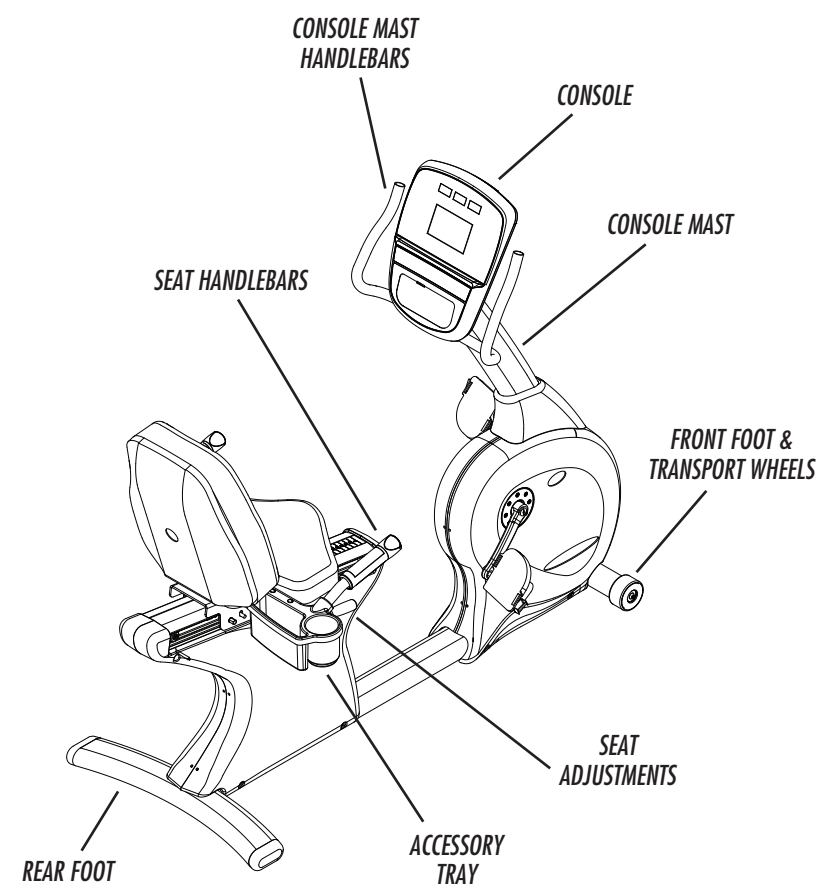

R 7 0
COMMERCIAL SEMI-RECUMBENT FITNESS BIKE

IMPORTANT SAFETY INSTRUCTIONS

SAVE THESE INSTRUCTIONS

When using an electrical product, basic precautions should always be followed, including the following: Read all instructions before using this exercise product.

Your VISION FITNESS Bike is self-generating (requiring no external power source) and must be pedaled to power-up the console.

WARNING! To reduce the risk of burns, fire, electrical shock or injury to persons:

- Use this exercise product for its intended use as described in this Owner's Guide. Only use attachments recommended by the manufacturer.
- Never drop or insert any object into any opening.
- Do not remove the Bike side covers. Service should be performed only by an authorized VISION FITNESS retailer.
- Never operate this Bike if it is not working properly or if it has been damaged or immersed in water. Return the Bike to a retailer for examination and repair.
- Do not use outdoors.

CHILDREN

- Keep children off of your Bike at all times.
- When the Bike is in use, young children and pets should be kept at least 10 feet away.

OTHER SAFETY TIPS FOR YOUR VISION FITNESS BIKE

CAUTION! If you experience chest pains, nausea, dizziness or shortness of breath, stop exercising immediately and consult your physician before continuing.

- Do not wear loose clothing that might catch on any part of the Bike.
- Read this Owner's Guide before operating this Bike.
- Drink plenty of fluids during your workout.

CLEANING

- Clean only with soap and a slightly damp cloth; never use solvents.

ASSEMBLY

It is recommended, when possible, that an authorized VISION FITNESS retailer assemble your Bike. If you have elected to assemble this product yourself, for your safety please read and follow each of the steps in the enclosed assembly instructions. If you have any questions regarding any part or function of your Bike, contact your retailer.

MOVING

Your VISION FITNESS Bike has transport wheels included for ease of mobility. To move your Semi-Recumbent Bike, firmly grasp the rear of the frame assembly, or the rear of the seat rail. Carefully lift and roll on the transport wheels. To move your Upright Bike, firmly grasp the handlebars, carefully tip toward you, and roll on the transport wheels.

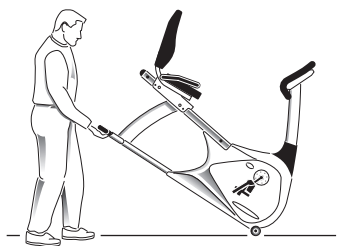

CAUTION: Our Bikes are well-built and heavy, weighing up to 160 pounds! Use care and additional help if necessary.

STABILIZING THE BIKE

After positioning the Bike in its intended location, check its stability by attempting to rock it side to side. Rocking or wobbling indicates that your Bike needs to be leveled. Determine which leveler is not resting completely on the floor. Loosen the wing nut at the base of the leveler to allow the leveler to rotate. Now rotate the leveler to the left or right until the Bike is stable. Lock the adjustment by tightening the wing nut against the rear foot support.



PEDAL STRAP ADJUSTMENT

The straps are designed to fit your individual foot size and should be adjusted tight enough to keep your feet from slipping. The pedals include spring-loaded clips for easy adjustment. To tighten the strap, pull down the open end of the strap. To loosen the strap, push down on the top of the clip and pull the strap up. Release the clip to lock in place.

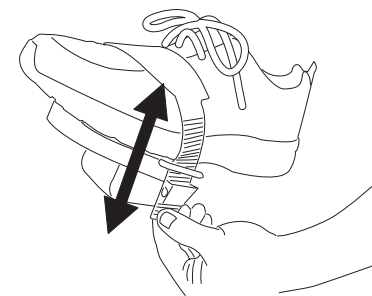

SEAT POSITIONING

To determine proper seat position, sit on the seat and position the ball of your foot on the center of the pedal. Your knee should bend slightly at the furthest pedal position. You should be able to pedal without locking your knees or shifting your weight from side to side.

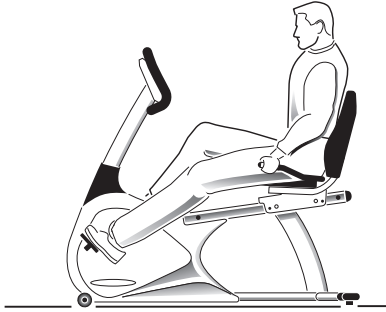

SEAT ADJUSTMENT

While seated on the Bike, lift the spring-loaded seat lever on the right side of the seat to make adjustments. Slide the seat forward or backward to desired location. Release the spring-loaded seat lever and gently attempt to rock forward and backward to assure it is locked in place.

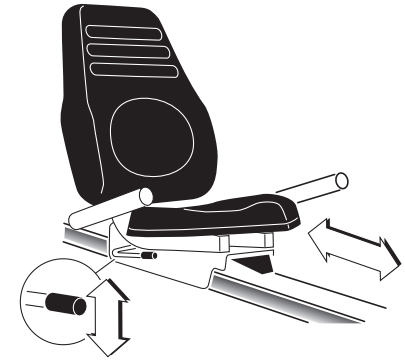

LUMBAR ADJUSTABLE SEAT

To adjust the lumbar support, turn the knob located on the right side of the back support cushion. To increase the lumbar support turn the knob in a clockwise direction; to decrease support turn the knob in a counterclockwise direction.

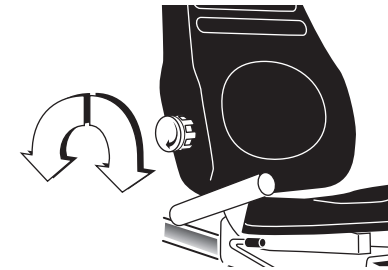

SELF-POWERED FEATURE

The *R70* is a self-powered unit, requiring no external power source. When a user pedals at a speed above 20 revolutions per minute (RPM), the power is generated to allow the Bike to function properly. Because of this self-generating feature, the console feedback will fade away when you cease pedaling. The console does, however, use a 9-volt battery as backup to save your feedback information for 30 seconds from the time you stopped pedaling. If you resume pedaling within the 30 seconds, the information will reappear. If the information does not appear within the 30 seconds, your battery may need to be plugged in or replaced.

CONTACT HEART RATE

HAND PULSE HEART RATE SENSORS

The Contact Hand Pulse Sensors are included on each product to monitor your heart rate. To use, grasp both of the sensors with a comfortable grip during your workout. The console will display your heart rate. Although your signal will be displayed immediately, it may take the system a few seconds to zero in on your actual heart rate.

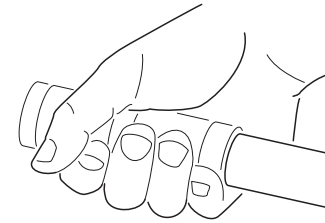

DISPLAY CONSOLE

DISPLAY CONSOLE OVERVIEW

The computerized display allows the user to select a workout that meets their desired fitness goals. It also allows the user to monitor the progress and feedback of each workout so they can track improvements in overall fitness over time.

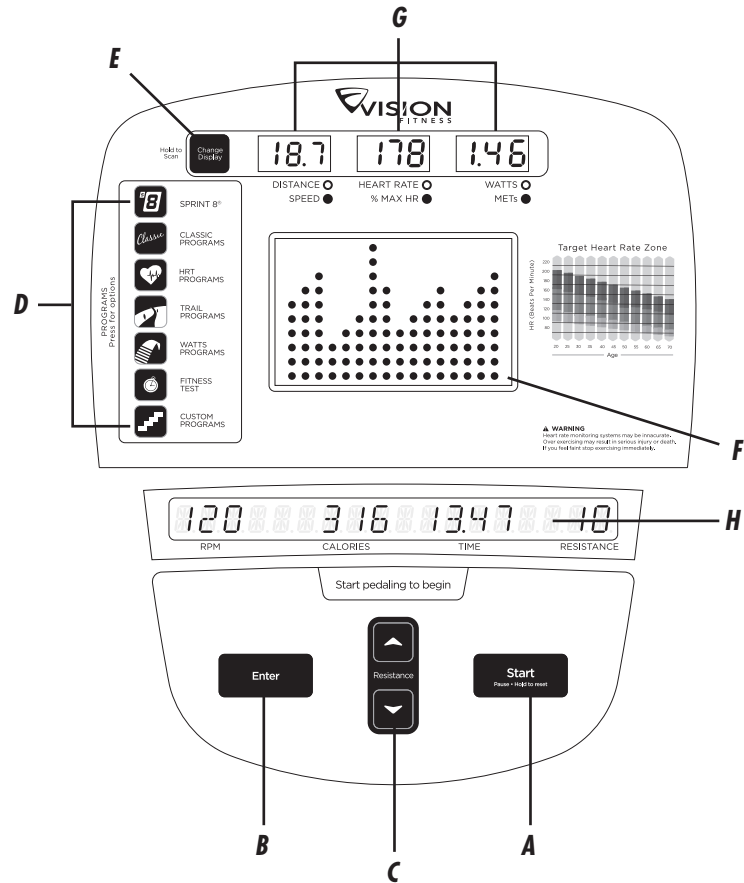

DISPLAY CONSOLE DESCRIPTIONS

A. START/HOLD TO RESET

Press the START key to begin a MANUAL workout immediately without having to set individual information. When the program begins, you have the ability to adjust resistance levels with the ARROW keys. Feedback information will be calculated using default settings.

PAUSE: If you need to PAUSE your program during a workout, pressing the START key will PAUSE your program for 30 seconds. Pressing START will return you to your workout.

RESET: If you need to RESET the console during your workout, you can do so by holding down the START button for three seconds or until the display resets.

B. ENTER

This key is used after entering each piece of information in setup such as age, weight, or level.

C. ARROW BUTTONS

These keys are used to change values in setup mode prior to your workout. During your workout, they are used to change workout levels. In HRT® programs, they are used to change your target heart rate.

D. PROGRAM BUTTONS

These keys provide quick access to your favorite workouts. Press the program repeatedly or use the arrow keys to select one of multiple workouts.

E. CHANGE DISPLAY / HOLD TO SCAN

Press to change display information. Press and hold to scan automatically between the two display options.

DISPLAY CONSOLE DESCRIPTIONS (continued)

F. PROFILE DISPLAY

This window provides a dot matrix profile of the workout segments you are about to complete, as well as those you have already completed, and the level of resistance for each segment.

G. FEEDBACK WINDOWS

These windows provide step-by-step instructions in the setup mode, instructions, feedback and motivational messages during your workout.

FEEDBACK:

During your workout, these windows display exercise feedback about your workout, including:

SPEED: the pedaling speed in miles or kilometers per hour.

DISTANCE: the total distance traveled in miles or kilometers since the start of your workout.

WATTS: a measurement of workload; one watt is equal to six kilogram-meters per minute.

METS: a measurement of oxygen consumption; one MET equals the approximate amount of oxygen consumed per minute by a person at rest.

HEART RATE/HRT FEEDBACK WINDOW

This window provides feedback on your current heart rate and the percent of your predicted maximum heart rate (% Heart Rate). It also includes your target heart rate when using one of the HRT® programs.

NOTE: At the end of your workout, the totals will be displayed as averages of your total workout time. The only exceptions are distance and calories, which are program totals.

H. MESSAGE WINDOW

This window provides step-by-step instructions in the setup mode, instructions, feedback and motivational messages during your workout.

TIME: the time elapsed or the time remaining in your workout.

RPM: the pedal rate or Revolutions Per Minute (RPM).

CALORIES: an estimate of calories burned since the beginning of the workout.

RESISTANCE: the current resistance level you are currently in.

CARDIO PORT

A Cardio Port is located on the back of the console that is compatible to entertainment protocol, such as Cardio Theatre. The bottom port is the active port to use for this function.

These ports are located on the backside of the console and are enclosed by removable covers.

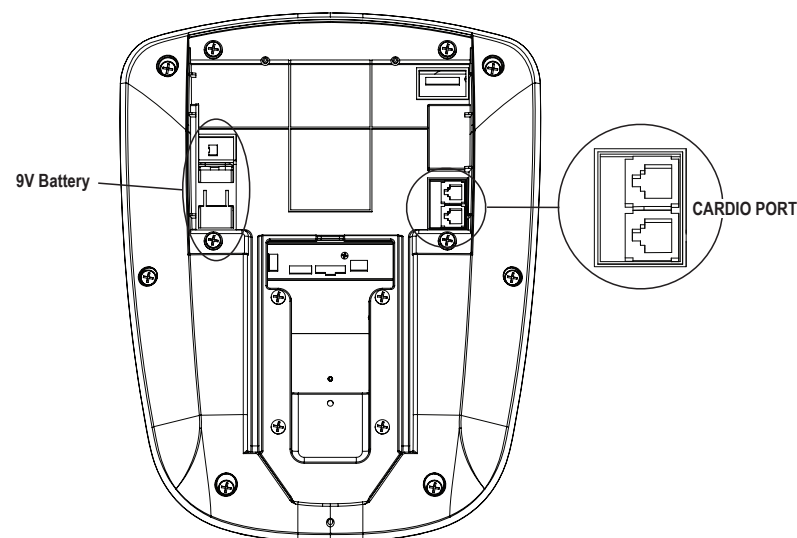

BATTERY: Your console is equipped with a 9V battery to maintain workout information.

PROGRAM OVERVIEWS

CONSOLE



SPRINT 8 is an anaerobically-based interval program. It is effective in recruiting fast twitch muscle fibers and improving athletic performance.



CLASSICS

MANUAL is a user-controlled program in which the resistance remains at a set level unless you decide to change it.

INTERVAL is an efficient workout that strengthens your cardiovascular system by alternating work intervals and recovery intervals. Be sure to challenge yourself with intense work intervals.

FAT BURN is a program designed to target your stored body fat. This program is generally used at a slightly lower resistance level but runs for longer durations than other programs.

RANDOM is a program that will give you a different workout every time you workout. The resistance levels will change randomly, providing a challenging workout.



HRT® PROGRAMS

TARGET HRT allows you set your target heart rate. The machine will automatically change resistance levels to keep you at your preset heart rate target. The user must grasp the hand pulse sensors or wear a telemetric heart rate chest strap during use.

HRT WEIGHT LOSS is a lower intensity workout that will help your body burn a higher percentage of calories from your body's fat reserves. The user must grasp the hand pulse sensors or wear a telemetric heart rate chest strap during use. The program will automatically adjust resistance to keep you at 65% of your predicted maximum heart rate.

HRT INTERVAL alternates between effort intervals of 80% and 70% of your predicted maximum heart rate. This program is designed to increase your cardiovascular fitness capacity. The user must grasp the hand pulse sensors or wear a telemetric heart rate chest strap during use.

HRT HILL increases your intensity level from 65%, to 70%, to 75%, to 80% of your predicted maximum heart rate to promote cardiovascular strength and endurance.

CONSOLE

PROGRAM OVERVIEWS CONTINUED



TRAILS

TRAIL 10K is a distance based program that ends after you complete the 10K. See if you can beat your previous time!

TRAIL 15K is a distance based program that ends after you complete the 15K. See if you can beat your previous time!

TRAIL 20K is a distance based program that ends after you complete the 20K. See if you can beat your previous time!



WATTS PROGRAMS

CONSTANT WATTS allows you to set your target WATT output (energy output). The resistance will change automatically to keep you at your target WATTS.

INTERVAL WATTS allows you to choose a high WATTS value and a low WATTS value. The interval program will switch between High and Low WATTS values, making for a very intense and effective workout.

HILL WATTS lets you choose four WATTS levels. Each WATTS level will change at 1 minute intervals and repeat until your preset workout time is over. Perfect for a challenging workout.



FITNESS TEST is a heart rate based fitness test. The test lasts 5 minutes and is based on your VO2 level and maximum heart rate achieved to provide an accurate fitness level. This is a great program to track your increase in fitness levels. The user must grasp the hand pulse sensors or wear a telemetric heart rate chest strap during use.



CUSTOM PROGRAMS

CUSTOM 1-5 allows you to preset up to five workout profiles. You have the ability to save or change the workouts whenever you wish. More information is available on page 26.

USING THE PROGRAMS

SELECTING EASY START

The easiest way to begin exercising is to simply press the START key. You will begin exercising in a MANUAL resistance program in which you can change the resistance levels to meet your goals. Current default settings will be used to determine exercise feedback.

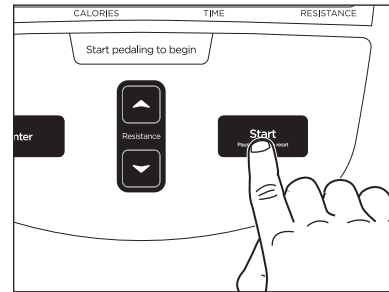

SELECTING A PROGRAM

Each program has its own program button. Some program buttons have multiple programs. Press the key of the program you would like to use. You can use the arrow keys or press the program key repeatedly to scroll through the different program options.

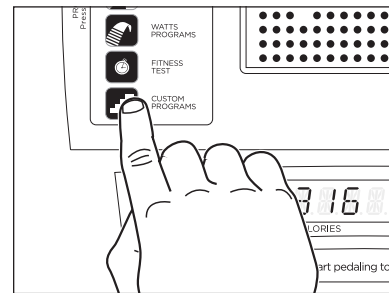

ENTERING AGE

When prompted by the message center to enter your age, use the UP ▲ arrow or DOWN ▼ arrow to adjust displayed age to the correct value. This information is necessary for the HRT® programs and will affect your "% Heart Rate" feedback.

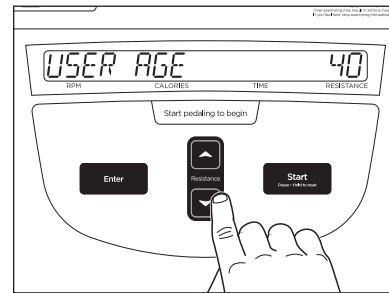

ENTERING TIME

When prompted by the message center to enter a time, use the UP ▲ arrow and DOWN ▼ arrow to adjust the displayed exercise time to a desired value.

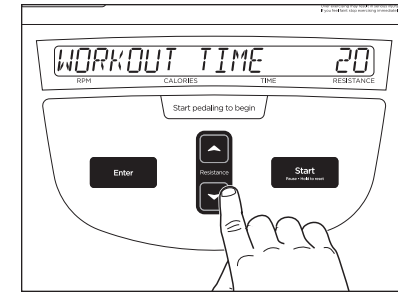

ENTERING RESISTANCE

When prompted by the message center to enter level, use the UP ▲ arrow and DOWN ▼ arrow to adjust the displayed resistance level. There are 20 levels of resistance to choose from in each program. The maximum resistance level varies by program.

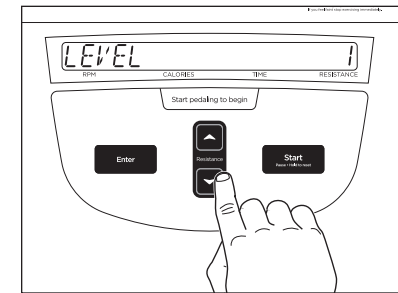

ENTERING WEIGHT

When prompted by the message center to enter weight, use the UP ▲ arrow and DOWN ▼ arrow to adjust the displayed weight to equal your current body weight. This information is necessary to give accurate exercise feedback for calorie and MET calculations.

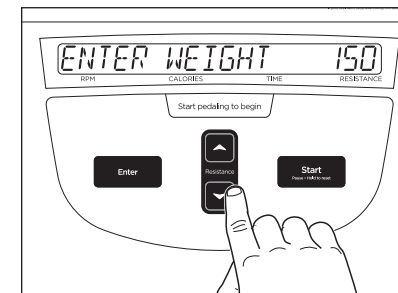

The WATTS programs will ask you to set the desired WATT level instead of resistance levels. The WATT level will range from 40 to 250 in increments of five.

The HRT programs will set your target heart rate in the place of resistance level. The console will display your target heart rate and give you the opportunity to adjust this value if you wish.

USING THE SPRINT 8 PROGRAM

The SPRINT 8 program is an anaerobic interval program designed to build muscle, improve speed, and naturally increase the release of Human Growth Hormone (HGH) in your body. Producing HGH through exercise and a proper diet has been shown as an effective way to burn fat and build lean muscle mass according to Phil Campbell, author of *Ready, Set, GO! SYNERGY FITNESS*. Please go to Mr. Campbell's website, www.readysetgofitness.com, for more details about this radical new approach to fitness.

The SPRINT 8 program features intense sprint intervals followed by recovery intervals. The program includes the following phases:

1. **WARM-UP** should gradually increase your heart rate and increase respiration and blood flow to working muscles. The warm-up is controlled by the user to meet your specific needs.
2. **INTERVAL TRAINING** starts immediately after the warm-up with a 30-second sprint interval. Seven recovery intervals of one minute and 30 seconds will alternate with the eight 30-second sprint intervals. The message display will prompt you to increase your pedal rate during the sprint interval and decrease pedal rate during the recovery interval. A difference of 30 to 50 RPM between sprint interval and recovery interval is recommended.
3. **COOL-DOWN** helps return your body's systems to resting levels. Less demand is placed on your heart during recovery if an appropriate cool-down is used following the exercise.

Due to the fact that this is a specialized training program, total workout time is not displayed during the program. The interval time is displayed in the time window instead. It takes only 20 minutes to complete the SPRINT 8 workout.

USING HEART RATE TRAINING

WHAT IS HEART RATE TRAINING?

Heart Rate Training means exercising at an intensity that keeps you in your ideal heart rate zone. Your personal heart rate training zone depends on your fitness goal, such as weight loss, cardiovascular endurance, or strength building. VISION FITNESS HRT® programs are set up to keep you at an ideal heart rate based on your fitness goal. These programs automatically adjust resistance based on your heart rate readings.

The console features four programs (Target HRT, HRT Weight Loss, HRT Interval, HRT Hill) that offer the benefits of Heart Rate Training. Refer to Page 17 for more details on these programs.

- *These programs use the predicted maximum heart rate formula (220 minus age) to determine your predicted maximum heart rate. Some individuals have higher or lower maximum heart rates than determined by this formula. The programs allow you to modify your Target Heart Rate to achieve your personal goals.*

HAND PULSE HEART RATE SENSORS

The Contact Hand Pulse Sensors are included on each product to monitor your heart rate. To use, grasp both of the sensors with a comfortable grip during your workout. The console will display your heart rate. Although your signal will be displayed immediately, it may take the system a few seconds to zero in on your actual heart rate.

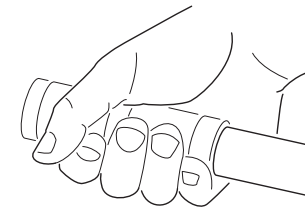

NOTE: The Contact Hand Pulse Sensors will work for the HRT® programs, but it is recommended to use the telemetric chest strap for an uninterrupted signal and ease of use.

TELEMETRIC HEART RATE CHEST STRAP

The wireless Telemetric Chest Strap uses a pair of electrodes on the underside of the strap to send your heart rate signal to the console. Prior to wearing the chest strap, moisten the two rubber electrode pads with several drops of water. These electrodes must remain wet to provide an accurate signal. We advise using the chest strap against your skin, but it also functions through a thin layer of wet clothing.

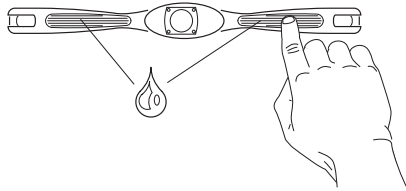

STRAP PLACEMENT

Center the transmitter strap just below the breast or pectoral muscles, directly over your sternum with the VISION FITNESS logo facing out. Adjust the elastic strap so it is snug but comfortable enough for proper breathing.

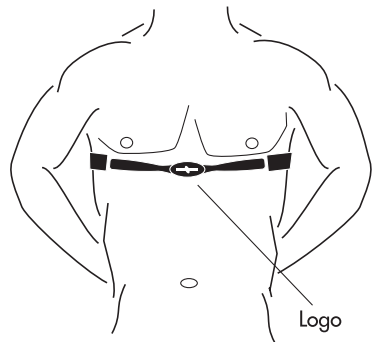

ALL HRT PROGRAMS

During the workout, the user will grasp the hand pulse sensors or wear the telemetric chest strap to send their heart rate signal to a receiver in the console. The console will continuously monitor the heart rate, adjusting the resistance level of the Bike to keep your heart rate within several beats of your target heart rate. By using the CHANGE DISPLAY key, the heart rate feedback window conveniently displays your Heart Rate or % Heart Rate to keep you informed about your current heart rate. Each program will begin with a two-minute warm-up. When the workout time has been completed, the console will begin a five-minute cool-down. The user will be responsible for adjusting resistance to meet their needs during the warm-up and cool-down.

ADJUSTING TARGET HEART RATE

While exercising in one of the HRT® programs, you may decide the target heart rate needs to be adjusted. To adjust your target heart rate, use the UP ▲ arrow or DOWN ▼ arrow. Push ENTER to select.

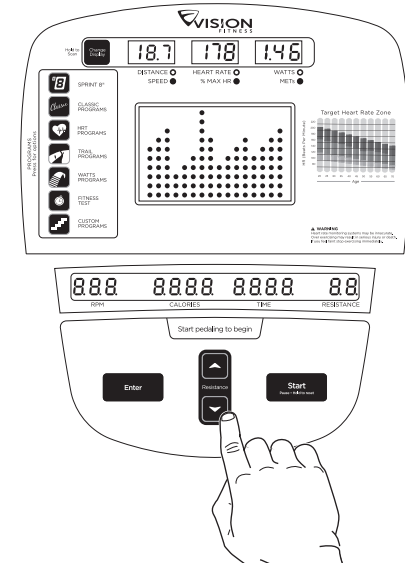

USING CUSTOM PROGRAMS

The CUSTOM programs allow five separate workout choices to be saved for future use. Press the Custom program button and select your desired CUSTOM program (1, 2, 3, 4, or 5). Set your age, time, and weight and begin your workout.

During initial setup, the program will function as a Manual program. Change your resistance levels as you want. At the end of the workout the console will ask if you would like to save your workout. Press and Hold ENTER to save the workout you just completed.

The next time you select that Custom program, the workout profile will show a representation of the changes in resistance levels on the brickyard. When you enter a Custom workout, any changes you make during the program can be saved at the end of the workout.

ENGINEERING MODE

Engineering mode consists of 15 optional settings. Use the engineering mode to enable certain features or displays on your console.

ENTERING AND USING ENGINEERING MODE

- Press and hold the UP and DOWN Resistance buttons for approximately 3 seconds.
- The console will beep three times.

OPTIONAL SETTINGS

SETTING	DESCRIPTION
MAX TIME	SET A MAXIMUM WORKOUT TIME
USER TIME	SET A DEFAULT TIME FOR ALL PROGRAMS
DF AGE	SET A DEFAULT AGE FOR ALL PROGRAMS
DF WEIGHT	SET A DEFAULT WEIGHT FOR ALL PROGRAMS
DF LEVEL	SET A DEFAULT LEVEL FOR ALL PROGRAMS
DF GENDER	SET A DEFAULT GENDER FOR ALL PROGRAMS
UNIT	SET THE DISTANCE VALUE TO MILES OR KILOMETERS
MACHINE	SET THE CONSOLE TO BIKE OR ELLIPTICAL MODE
AC TIME	DISPLAY ACCUMULATED HOURS OF USE
AC DIST	DISPLAY ACCUMULATED MILES OR KM OF USE
DISPLAY TEST	USED BY SERVICE TECHNICIANS TO TEST LED DISPLAYS
MACHINE TEST	USED BY SERVICE TECHNICIANS TO TEST MECHANICAL AND CSAFE FUNCTIONS
KEYPAD TEST	TEST TO ENSURE ALL BUTTONS ARE FUNCTIONING PROPERLY
VERSION	DISPLAY CURRENT SOFTWARE VERSION
LANGUAGE	CHANGE THE DEFAULT LANGUAGE IF AVAILABLE

- Use the Up and Down buttons to change the setting.
- Press and Hold Enter for 3 seconds to save the change.
- To back out of sub menu or exit to main menu, Press and Hold Start for 3 seconds.

SERVICE AND TROUBLESHOOTING

PREVENTATIVE MAINTENANCE TIPS

- Locate Bike in a cool, dry place.
- Clean the top surface of the pedals regularly.
- Make sure pedals are kept tight to crank arms.
- Keep the display console free from fingerprints and salt buildup caused by sweat.
- Use a cotton cloth with water and a mild cleaning product to clean the Bike. Other fabrics, including paper towels, may scratch the surface. Do not use ammonia or acid-based cleaners.
- Clean the housing thoroughly on a regular basis.

PREVENTATIVE MAINTENANCE SCHEDULE

Follow the schedule below to ensure proper operation of the product.

ITEM	WEEKLY	MONTHLY	BI-ANNUALLY	ANNUALLY
DISPLAY CONSOLE	CLEAN	INSPECT		
CONSOLE MOUNTING BOLTS			INSPECT	
FRAME	CLEAN			INSPECT
SEAT FRAME	CLEAN	INSPECT		
HANDLEBARS	CLEAN	INSPECT		
PLASTIC COVERS	CLEAN	INSPECT		
PEDALS AND STRAPS	CLEAN	INSPECT		
SEAT	CLEAN		INSPECT	

TROUBLESHOOTING

Our Bikes are designed to be reliable and easy to use. If, however, you have a problem, these troubleshooting steps may reveal the cause.

PROBLEM: The console does not light up.

SOLUTION: Make sure you are pedaling the Bike.

SOLUTION: Make sure the wire harness is plugged into the back of the console.

PROBLEM: The Bike is making a clicking noise.

SOLUTION: Using the pedal wrench supplied with your Bike, remove both the left and right pedals, apply grease to the threaded portion and reassemble the pedals onto the Bike. Make sure the pedals are tight.

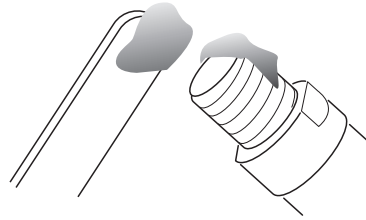

SOLUTION: Make sure the pedal straps or your shoe laces are not hitting the side cover.

SOLUTION: Assure seat adjustment is tight (see pages 10 and 11).

PROBLEM: The Bike makes a squeaking or creaking noise.

SOLUTION: Check and tighten all hardware.

PROBLEM: The seat on your semi-recumbent Bike rocks from side to side.

SOLUTION: With a 13mm wrench, loosen the Fixing Nuts on the side of the seat frame. With an 11mm wrench, pivot the Adjusting Post so the Fixing Nut is at the top of the slot. Tighten the Fixing Nut with the 13mm wrench.

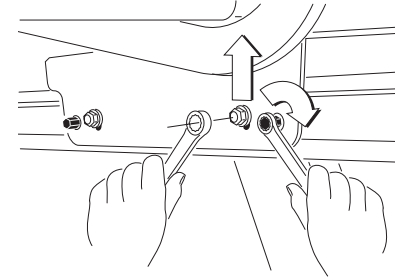

NOTE: If the above steps fail to remedy the problem, discontinue use, turn the power off and contact your retailer.

OBTAINING SERVICE

Do not attempt to service this Bike yourself except for the maintenance tasks described in this manual. For information on service to your VISION FITNESS Bike, contact the local retailer from whom you purchased the Bike. To expedite service, please make sure to have your serial number available. The serial number is found on a label located on the front support tube of your Bike.

SERIAL NUMBER: _____

TROUBLESHOOTING YOUR HEART RATE MONITOR CHEST STRAP

PROBLEM: No pulse reading appears.

SOLUTION: There may be a poor connection between the contact pads and skin; remoisten the electrode pads.

SOLUTION: Transmitter is not properly positioned; reposition the chest strap.

SOLUTION: Verify that the distance between the transmitter and receiver is not beyond the recommended range of 36 inches.

PROBLEM: There is an erratic pulse rate.

SOLUTION: Chest strap is too loose; readjust according to directions.

NOTE: It is possible that heart rate monitors will not function properly on some people for a variety of reasons. It may be necessary to experiment with the fit and position of the chest strap. Outside interference sources such as computers, motors, electric dog fences, home security systems, remote controls, CD players, fluorescent lights, etc., may cause problems for heart rate monitors.

LIMITED HOME USE WARRANTY

NOTE: Warranty subject to change. For latest warranty information, please visit www.visionfitness.com.

VISION FITNESS extends the following exclusive, limited warranty, which shall apply only to the use of the device in the home, for residential, non-commercial purposes. Any other use of the device shall void this warranty.

VISION FITNESS hereby extends the following limited warranties for the following components of the device, for the time period indicated:

FRAME - LIFETIME VISION FITNESS warrants the Frame against defects in workmanship and materials for the life of the product, so long as it remains in the possession of the original owner. The frame is defined as the welded metal base of the unit and does not include any parts that can be removed.

CAMBRIDGE MOTOR WORKS™ GENERATOR SYSTEM - LIFETIME VISION FITNESS warrants the Cambridge Motor Works™ Generator System against defects in workmanship and materials for the life of the product, so long as the device remains in the possession of the original owner.

ELECTRONICS & PARTS - SEVEN YEARS VISION FITNESS warrants the Electronic components and all original Parts against defects in workmanship and materials for a period of seven years from the date of purchase, so long as the device remains in the possession of the original owner.

LABOR - TWO YEARS VISION FITNESS shall cover the Labor cost for the repair of the device for a period of two years from the date of original purchase, so long as the device remains in the possession of the original owner.

LIMITED HOME USE WARRANTY (continued)

EXCLUSIVE REMEDY

The exclusive remedy for any of the above warranties shall be repair or replacement of defective Parts, or the supply of Labor to cure any defect, provided that Labor shall be limited to two years. All Labor shall be supplied by the local Retailer and the product must be located within that Retailer's service area. Products located outside the Retailer's service area will not be covered by the Labor warranty.

EXCLUSIONS AND LIMITATIONS

This warranty applies only to the original owner and is not transferable. This warranty is expressly limited to the repair or replacement of a defective Frame, Cambridge Motor Works™ Generator, Electronic component, or defective Part and is the sole remedy of the warranty. The warranty does not cover normal wear and tear, improper assembly or maintenance, or installation of parts or accessories not originally intended or compatible with the Fitness Product as sold. The warranty does not apply to damage or failure due to accident, abuse, corrosion, discoloration of paint or plastic, or neglect. VISION FITNESS shall not be responsible for incidental or consequential damages. Parts and Electronic components reconditioned to As New Condition by VISION FITNESS or its vendors may sometimes be supplied as warranty replacement parts and constitute fulfillment of warranty terms. Any warranty replacement parts shall be warranted for the remainder of the original warranty term.

VISION FITNESS expressly disclaims all other warranties, express or implied, including but not limited to all warranties of fitness for a particular purpose or of merchantability. This warranty gives you specific legal rights, and your rights may vary from state to state.

WARRANTY REGISTRATION

Your warranty registration must be completed before a warranty claim can be processed. You may register via our website at www.visionfitness.com. We are certain you will enjoy your new bike. Thank you for selecting a VISION FITNESS product.

COMMERCIAL WARRANTY

NOTE: Warranty subject to change. For latest warranty information, please visit www.visionfitness.com.

COMMERCIAL USES DEFINED VISION FITNESS warrants the R70 model bike for use in commercial facilities including: Hotels; Resorts; Police & Fire Stations; Apartment Complexes; Corporate Fitness Centers; Hospitals; Rehabilitation and Sports Medicine Clinics, where average use is up to six hours per day.

FRAME - LIFETIME VISION FITNESS warrants the Frame against defects in workmanship and materials for the lifetime of the original owner, so long as the device remains in the possession of the original owner. The frame is defined as the welded metal base of the unit and does not include any parts that can be removed.

CAMBRIDGE MOTOR WORKS™ GENERATOR SYSTEM, ELECTRONICS & PARTS - FIVE YEARS VISION FITNESS warrants the Generator System, Electronics & Parts against defects in workmanship and materials for a period of five years from date of original purchase, so long as the device remains in the possession of the original owner.

LABOR - TWO YEARS For a period of two years from the date of purchase, VISION FITNESS, through its local retailers, will provide the necessary Labor for repair and replacement of Frames, Electronics, Motors, and Parts under this warranty, so long as the device remains in the possession of the original owner.

COMMERCIAL WARRANTY (continued)

EXCLUSIVE REMEDY

The exclusive remedy for any of the above warranties shall be repair or replacement of defective Parts or the supply of Labor to cure any defect, provided that the Labor be limited to one year.

EXCLUSIONS AND LIMITATIONS

This warranty applies only to the original owner and is not transferable. This warranty is expressly limited to the repair or replacement of a defective Frame, Electronic component, or defective Part and is the sole remedy of the warranty. The warranty does not cover normal wear and tear – including but not limited to seats, pedals and straps, hand grips, entertainment ports, improper assembly or maintenance, or installation of parts or accessories not originally intended or compatible with the Fitness Product as sold. This warranty does not apply to damage or failure due to accident, abuse, corrosion, discoloration of paint or plastic or neglect. VISION FITNESS shall not be responsible for incidental or consequential damages. Parts and Electronic components reconditioned to As New Condition by VISION FITNESS or its vendors may sometimes be supplied as warranty replacement parts and constitute fulfillment of warranty terms. Any warranty replacement parts shall be warranted for the remainder of the original warranty term.

VISION FITNESS expressly disclaims all other warranties, expressed or implied, including but not limited to all warranties of fitness for a particular purpose or of merchantability. This warranty gives you specific legal rights, and your rights may vary from state to state.

WARRANTY REGISTRATION

Your warranty registration must be completed before a warranty claim can be processed. You may register via our website at www.visionfitness.com. We are certain you will enjoy your new bike. Thank you for selecting a VISION FITNESS product.

DEVELOPING A FITNESS PROGRAM

By purchasing this piece of VISION FITNESS exercise equipment, you have made a commitment to exercise and now have the convenience of exercising in your own home. Your new equipment offers the flexibility to exercise at whatever time suits you best. It will be easier to maintain a consistent exercise program that will help you achieve your fitness goals.

ACHIEVING YOUR FITNESS GOALS

An important step in developing a long-term fitness program is to determine your goals. Is your primary goal to lose weight? Improve muscle tone? Relieve stress? Prepare for the spring racing schedule? Knowing what your goals are will help you develop a more successful exercise program. If possible, try to define your personal goals in precise, measurable terms over specific periods of time. Examples of these goals might include:

- Decrease your waistline by two inches over the next two months.
- Run the local 5K race this summer.
- Get 30 minutes of cardiovascular exercise at least five days per week.
- Improve your race time by two minutes over the next year.
- Move from walking a mile to jogging a mile within the next three months.

The more specific the goal, the easier it will be to track your progress. If your goals are long-term, divide them into monthly and weekly segments. Long-term goals can lose some of the motivational benefits. Short-term goals are easier to achieve and will allow you to see the progress you are making. Every time you reach a goal, it is important to set a new goal. This will lead to a healthier lifestyle and will provide the motivation that you will need to move forward.

TRACK YOUR PROGRESS

Now that you have set your exercise goals, it is time to write them down and make an exercise schedule that will help you achieve them. By keeping a fitness diary, you will stay motivated and know where you are in terms of reaching your goals. As time goes on, you will be able to look back with pride to see how far you've come. For your convenience, we have included exercise log sheets in the wellness tools section of our website at www.visionfitness.com.

EXERCISE GUIDELINES

EXERCISE DURATION

A common question asked is, "how much exercise do I need?" We recommend following the guidelines set up by the American College of Sports Medicine (ACSM) for healthy aerobic activity.

- Exercise three to five days per week.
- Warm up for five to 10 minutes before aerobic activity.
- Maintain your exercise activity for 30 to 45 minutes.
- Gradually decrease the intensity of your workout, then stretch to cool down during the last five to 10 minutes.

If weight loss is a major goal, participate in your aerobic activity at least 30 minutes for five days each week.

EXERCISE INTENSITY

The next question asked is, "how hard do I need to work out?" To reap the most cardiovascular benefits from your workout, it is necessary to exercise within a recommended intensity range. We recommend monitoring your exercise heart rate to measure exercise intensity.

TARGET HEART RATE

Target Heart Rate is a percentage of your maximum heart rate. Target Heart Rate will vary for each individual depending on age, current level of conditioning, and personal fitness goals. Exercise heart rate should range from 55% to 85% of your maximum heart rate. As a point of reference, we use the predicted maximum heart rate formula of (220 minus age) to determine your heart rate training zone. Please use the following chart to determine your predicted Target Heart Rate.

TARGET HEART RATE ZONES Beats Per Minute 										
85%	178	170	161	153	144	136	127	119	110	102
75%	157	150	142	135	127	120	112	105	97	90
65%	136	130	123	117	110	104	97	91	84	78
55%	115	110	104	99	93	88	82	77	71	66
Percentage of Maximum Heart Rate										
AGE	10	20	30	40	50	60	70	80	90	100

EXAMPLE:

If you are a 30-year-old, your predicted maximum heart rate is 190 based on the (220 minus age) formula.

$$220 - 30 = 190$$

Based on the chart above, your heart rate training zone is 104 to 161, which is 55%–85% of 190.

BALANCED FITNESS

While cardiovascular exercise has been the primary method of fitness for many programs over the years, it should not be the only method. Strength Training and Flexibility Training have become more popular as exercise has developed. Incorporating Strength and Flexibility Training into your current exercise program will give you the balance you need to improve your athletic performance, reduce susceptibility to injury, increase metabolic rate, increase bone density, and reach your goals faster.

STRENGTH TRAINING

Strength Training was once known as an activity performed by young males only. That has changed with the advances in scientific research on Strength Training over the last 20 years or so. Research has proven that, after age 30, we begin to lose muscle mass if we do not incorporate Strength Training into our exercise program. With this decrease in muscle mass, our ability to burn calories decreases, our physical ability to do work decreases and our susceptibility to injuries increases. The good news is that, with a proper Strength Training program, we can maintain or even build muscle as we age. A proper Strength Training program will work the muscle groups of the upper and lower body. There are now many options available for Strength Training including: yoga, Pilates, selectorized machines, free weights, stability balls or medicine balls, exercise tubing and body weight exercises, just to name a few.

Recommendations for a minimum Strength Training program include:

FREQUENCY: Two to three days per week

VOLUME: One to three sets consisting of eight to 12 repetitions.

go with confidence™

1600 Landmark Drive • Cottage Grove, WI 53527
toll free 800.335.4348 • fax 608.839.8731
www.visionfitness.com

©2012 Vision Fitness. All Rights Reserved. Comfort Arc, ECB-Plus, HRT,
Quiet-Glide, and SPRINT 8 are Trademarks of Vision Fitness.

REV3